

OVERHEAD CRANES

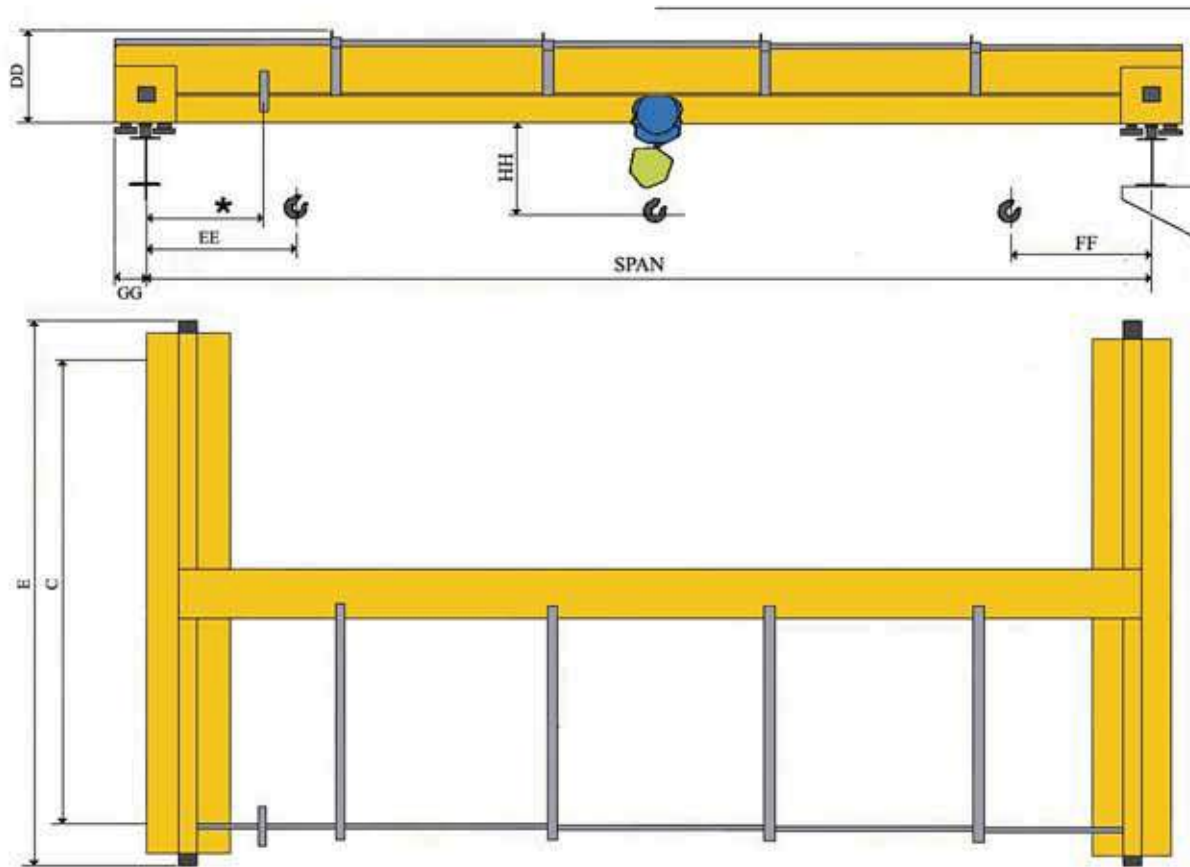

- SINGLE GIRDER & DOUBLE GIRDER
- TOP RUNNING & UNDER RUNNING
- MOTORIZED & HAND GEARED
- CUSTOM DESIGNS AVAILABLE



**Geared Top Running Single Girder
TYPE TR-G**

Capacity Tons	Span	C	E	DD	EE	FF	GG	HH
2	< 20'	5'-0"	6'-8"	1'-1"	11"	11"	8"	1'-8"
	20' - 30'	5'-0"	6'-8"	1'-7"	11"	11"	8"	1'-8"
	30' - 40'	5'-0"	7'-8"	1'-9"	11"	11"	8"	1'-8"
	40' - 50'	8'-0"	8'-8"	2'-0"	11"	11"	8"	1'-8"
	50' - 60'	8'-0"	11'-8"	2'-3"	11"	11"	8"	1'-8"
3	<20'	5'-0"	6'-8"	1'-3"	1'-0	1'-0	8"	1'-10"
	20' - 30'	5'-0"	6'-8"	1'-7"	1'-0	1'-0	8"	1'-10"
	30' - 40'	5'-0"	7'-8"	1'-9"	1'-0	1'-0	8"	1'-10"
	40' - 50'	8'-0"	8'-8"	2'-3"	1'-0	1'-0	8"	1'-10"
	50' - 60'	8'-0"	11'-8"	2'-10"	1'-0	1'-0	8"	1'-10"
5	<20'	5'-0"	6'-8"	1'-7"	1'-1"	1'-1"	8"	2'-6"
	20' - 30'	5'-0"	6'-8"	1'-9"	1'-1"	1'-1"	8"	2'-6"
	30' - 40'	5'-0"	7'-8"	2'-1"	1'-1"	1'-1"	8"	2'-6"
	40' - 50'	8'-0"	8'-8"	2'-4"	1'-1"	1'-1"	8"	2'-6"
	50' - 60'	8'-0"	11'-8"	2'-11"	1'-1"	1'-1"	8"	2'-6"
7	<20'	5'-0"	6'-8"	1'-7"	1'-3½"	1'-3½"	8"	2'-10½"
	20' - 30'	5'-0"	6'-8"	2'-0"	1'-3½"	1'-3½"	8"	2'-10½"
	30' - 40'	5'-0"	7'-8"	2'-2"	1'-3½"	1'-3½"	8"	2'-10½"
	40' - 50'	8'-0"	8'-8"	2'-2"	1'-3½"	1'-3½"	8"	2'-10½"
	50' - 60'	8'-0"	11'-8"	2'-9"	1'-3½"	1'-3½"	8"	2'-10½"
10	<20'	5'-0"	6'-8"	1'-9"	1'-3½"	1'-3½"	8"	2'-10½"
	20' - 30'	5'-0"	6'-8"	2'-0"	1'-3½"	1'-3½"	8"	2'-10½"
	30' - 40'	5'-0"	7'-8"	2'-2"	1'-3½"	1'-3½"	8"	2'-10½"
	40' - 50'	8'-0"	8'-8"	2'-9"	1'-3½"	1'-3½"	8"	2'-10½"
	50' - 60'	8'-0"	11'-8"	2'-9"	1'-3½"	1'-3½"	8"	2'-10½"

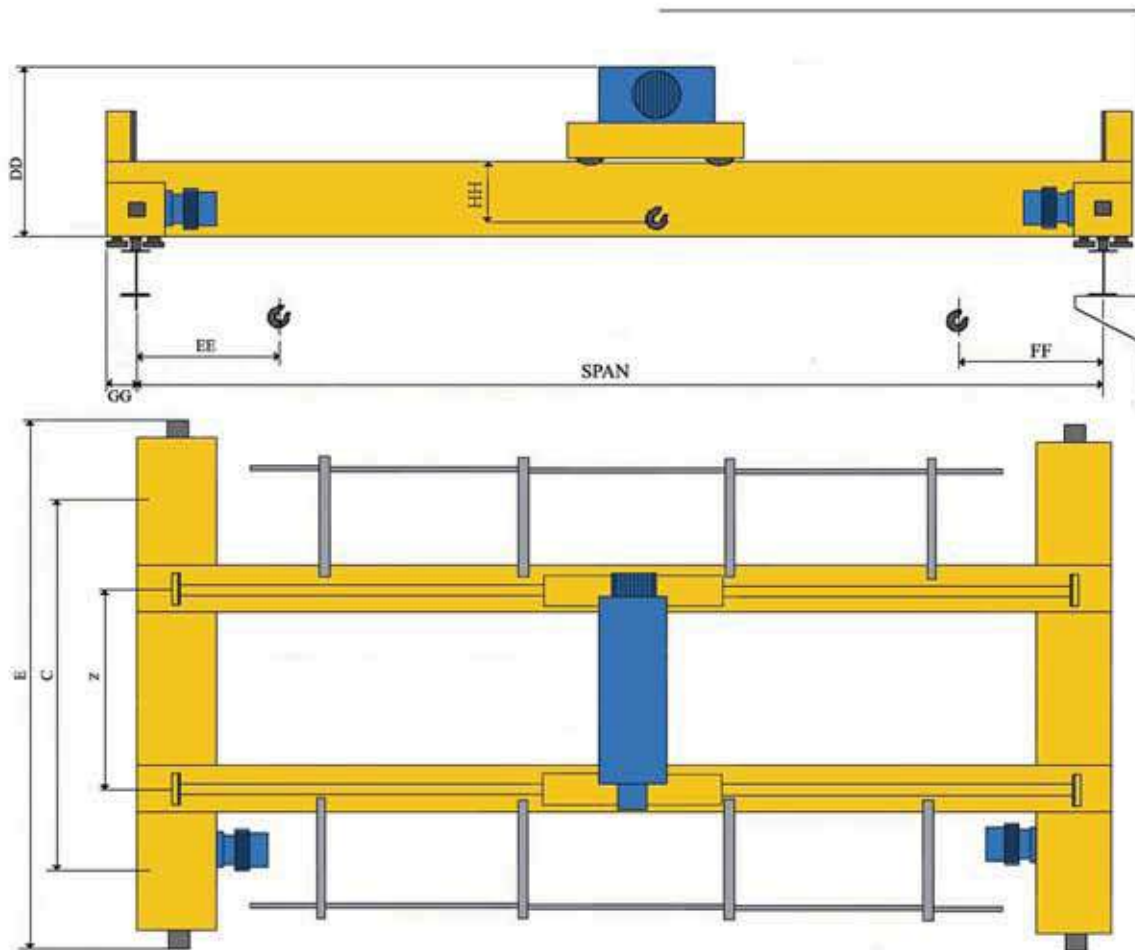

**Double Girder Top Running Motorized Crane Bridge
TYPE TR-DR**

Capacity Tons	Span	C	E	DD	EE	FF	GG	HH	Horse Power	Z	Sq. Bar*
5	< 20'	6'-6"	9'-6"	4'-8½"	2'-10"	3'-0"	8"	1'-11"	2x1.0	4'-0"	1½"x1½"
	20' - 40'	8'-3"	11'-3"	4'-11½"	2'-10"	3'-0"	8"	1'-11"	2x1.0	4'-0"	1½"x1½"
	40' - 60'	10'-6"	15'-6"	5'-6"	2'-10"	3'-0"	8"	1'-11"	2x1.45	6'-0"	1½"x1½"
	60' - 80'	12'-8"	15'-9"	6'-9½"	2'-10"	3'-0"	8"	1'-11"	2x1.45	6'-0"	1½"x1½"
	80' - 100'	14'-10"	18'-3"	7'-9½"	2'-10"	3'-0"	8"	1'-11"	2x1.45	6'-0"	2"x2½"
7	<20'	6'-6"	9'-6"	4'-8½"	2'-10"	3'-0"	8"	2'-4"	2x1.25	4'-0"	1½"x1½"
	20' - 40'	8'-3"	11'-3"	5'-6½"	2'-10"	3'-0"	8"	2'-4"	2x1.25	4'-0"	1½"x1½"
	40' - 60'	10'-6"	15'-6"	5'-9"	2'-10"	3'-0"	8"	2'-4"	2x1.45	6'-0"	1½"x1½"
	60' - 80'	12'-8"	15'-9"	7'-1½"	2'-10"	3'-0"	8"	2'-4"	2x1.45	6'-0"	2"x2"
	80' - 100'	14'-10"	18'-3"	7'-11½"	2'-10"	3'-0"	8"	2'-4"	2x1.45	6'-0"	2"x2"
10	<20'	6'-6"	9'-6"	4'-8½"	3'-6"	3'-8"	8"	2'-6"	2x1.45	4'-0"	1½"x1½"
	20' - 40'	8'-3"	11'-3"	4'-11½"	3'-6"	3'-8"	8"	2'-6"	2x1.45	4'-0"	1½"x1½"
	40' - 60'	10'-6"	15'-6"	5'-9"	3'-6"	3'-8"	8"	2'-6"	2x2.0	6'-0"	2"x2"
	60' - 80'	12'-8"	15'-9"	7'-1½"	3'-6"	3'-8"	8"	2'-6"	2x2.0	6'-0"	2"x2"
	80' - 100'	14'-10"	18'-3"	7'-9½"	3'-6"	3'-8"	8"	2'-6"	2x2.0	6'-0"	2"x2"
15	<20'	10'-6"	13'-7"	4'-11"	4'-0"	4'-0"	1'-0"	2'-8"	2x1.45	4'-0"	2"x2"
	20' - 40'	10'-6"	13'-7"	5'-2"	4'-0"	4'-0"	1'-0"	2'-8"	2x1.56	4'-0"	2"x2"
	40' - 60'	11'-0"	14'-5"	6'-2½"	4'-0"	4'-0"	1'-0"	2'-8"	2x2.0	6'-0"	2"x2"
	60' - 80'	13'-2"	16'-7"	7'-8"	4'-0"	4'-0"	1'-0"	2'-8"	2x2.0	6'-0"	-
	80' - 100'	15'-2"	18'-7"	8'-4"	4'-0"	4'-0"	1'-0"	2'-8"	2x3.2	6'-0"	-
20	<20'	10'-6"	13'-7"	5'-3"	4'-6"	4'-6"	1'-0"	3'-4"	2x1.45	4'-0"	2"x2"
	20' - 40'	10'-6"	13'-7"	5'-9"	4'-6"	4'-6"	1'-0"	3'-4"	2x1.45	4'-0"	2"x2"
	40' - 60'	11'-0"	14'-5"	6'-6½"	4'-6"	4'-6"	1'-0"	3'-4"	2x2.0	6'-0"	-
	60' - 80'	13'-6"	16'-7"	8'-4"	4'-6"	4'-6"	1'-0"	3'-4"	2x3.2	6'-0"	-
	80' - 100'	15'-2"	18'-7"	9'-0"	4'-6"	4'-6"	1'-0"	3'-4"	2x3.2	6'-0"	-

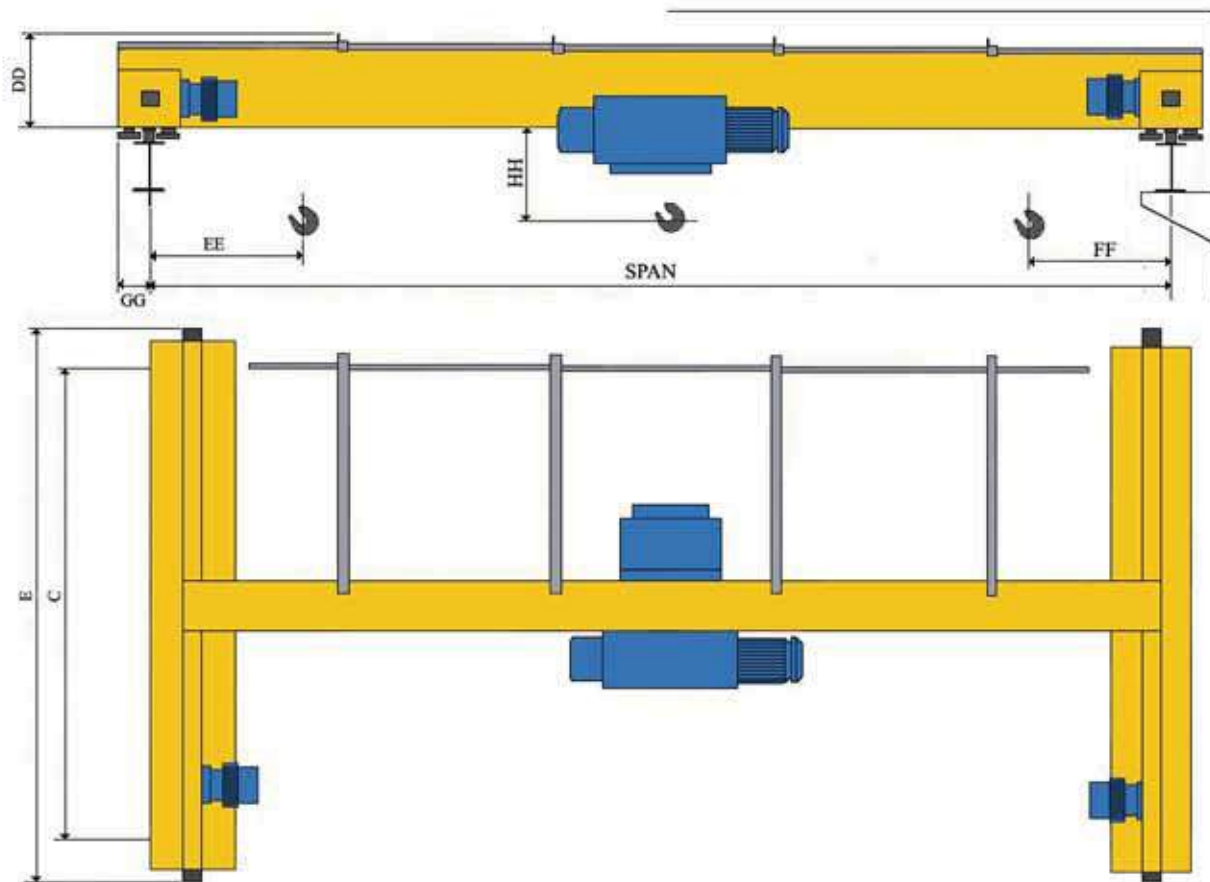

Single Girder Top Running Motorized Crane Bridge
TYPE TR-S

Capacity Tons	Span	C	E	DD	EE	FF	GG	HH	Horse Power
2	< 20'	5'-0"	6'-8"	1'-1"	2'-7"	2'-10"	8"	1'-10 1/2"	2x .33
	20' - 30'	5'-0"	6'-8"	1'-7"	2'-7"	2'-10"	8"	1'-10 1/2"	2x .33
	30' - 40'	6'-0"	7'-8"	1'-9"	2'-7"	2'-10"	8"	1'-10 1/2"	2x .33
	40' - 50'	7'-0"	8'-8"	2'-0"	2'-7"	2'-10"	8"	1'-10 1/2"	2x .50
	50' - 60'	10'-0"	11'-8"	2'-3"	2'-7"	2'-10"	8"	1'-10 1/2"	2x .50
3	<20'	5'-0"	6'-8"	1'-3"	2'-7"	2'-10"	8"	1'-10 1/2"	2x .30
	20' - 30'	5'-0"	6'-8"	1'-7"	2'-7"	2'-10"	8"	1'-10 1/2"	2x .50
	30' - 40'	6'-0"	7'-8"	1'-9"	2'-7"	2'-10"	8"	1'-10 1/2"	2x .50
	40' - 50'	7'-0"	8'-8"	2'-3"	2'-7"	2'-10"	8"	1'-10 1/2"	2x .50
	50' - 60'	10'-0"	11'-8"	2'-10"	2'-7"	2'-10"	8"	1'-10 1/2"	2x .80
5	<20'	5'-0"	6'-8"	1'-7"	2'-11"	3'-4"	8"	2'-2 3/4"	2x .50
	20' - 30'	5'-0"	6'-8"	1'-9"	2'-11"	3'-4"	8"	2'-2 3/4"	2x .50
	30' - 40'	6'-0"	7'-8"	2'-1"	2'-11"	3'-4"	8"	2'-2 3/4"	2x .80
	40' - 50'	7'-0"	8'-8"	2'-4"	2'-11"	3'-4"	8"	2'-2 3/4"	2x 1.20
	50' - 60'	10'-0"	11'-8"	2'-11"	2'-11"	3'-4"	8"	2'-2 3/4"	2x 1.20
7	<20'	5'-0"	6'-8"	1'-7"	2'-9"	3'-7"	8"	2'-4"	2x .50
	20' - 30'	5'-0"	6'-8"	2'-0"	2'-9"	3'-7"	8"	2'-4"	2x .80
	30' - 40'	6'-0"	7'-8"	2'-2"	2'-9"	3'-7"	8"	2'-4"	2x 1.10
	40' - 50'	7'-0"	8'-8"	2'-2"	2'-9"	3'-7"	8"	2'-4"	2x 1.45
	50' - 60'	10'-0"	11'-8"	2'-9"	2'-9"	3'-7"	8"	2'-4"	2x 1.45
10	<20'	5'-0"	6'-8"	1'-9"	2'-10"	3'-8"	8"	2'-11"	2x .80
	20' - 30'	5'-0"	6'-8"	2'-0"	2'-10"	3'-8"	8"	2'-11"	2x 1.10
	30' - 40'	6'-0"	7'-8"	2'-2"	2'-10"	3'-8"	8"	2'-11"	2x 1.45
	40' - 50'	7'-0"	8'-8"	2'-9"	2'-10"	3'-8"	8"	2'-11"	2x 1.45
	50' - 60'	10'-0"	11'-8"	2'-9"	2'-10"	3'-8"	8"	2'-11"	2x 1.45

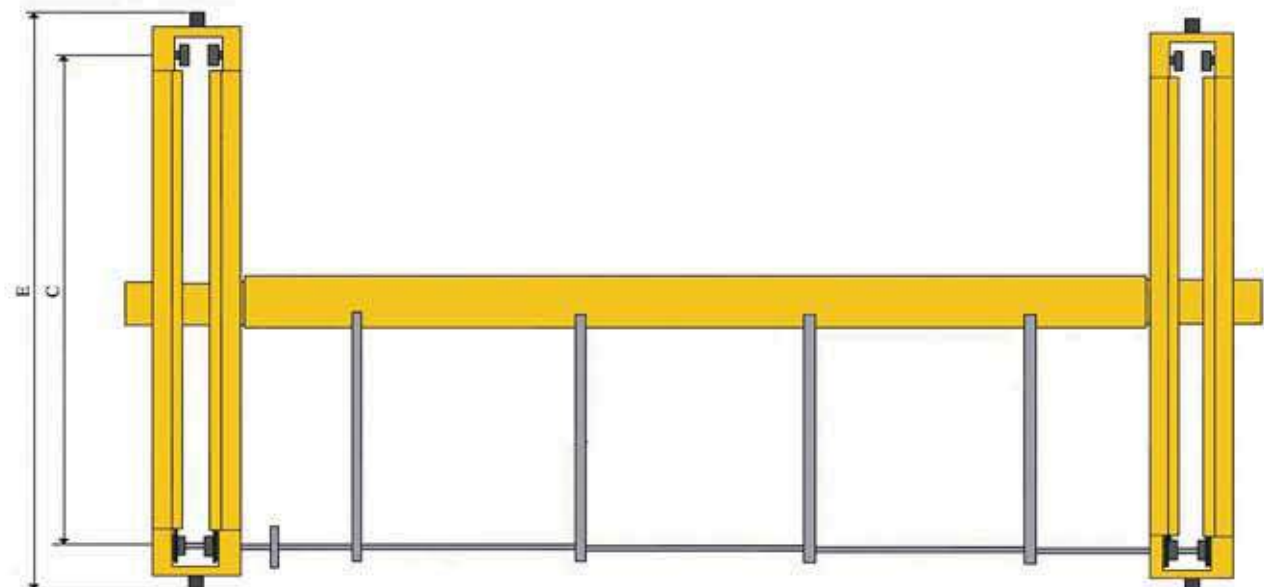
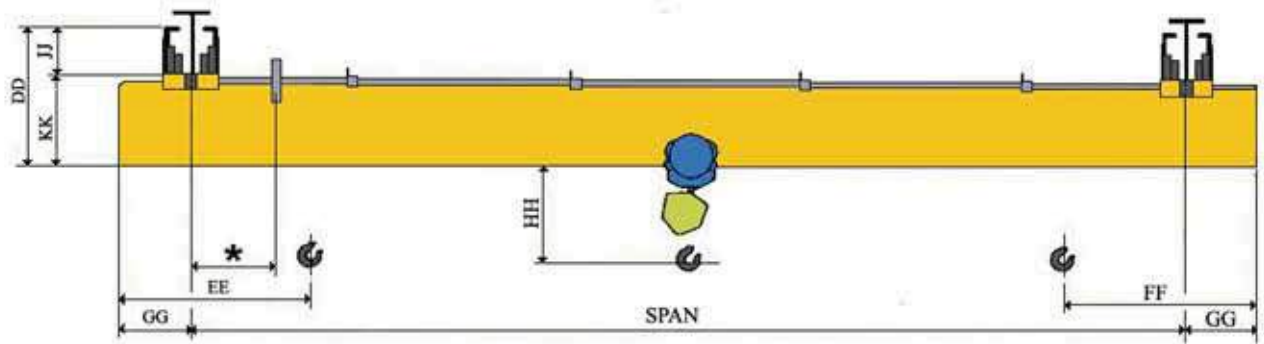

**Geared Single Girder Underslung Crane Bridge
TYPE UR-G**

Capacity Tons	Span	C	E	DD	EE	FF	GG	HH	JJ	KK
2	< 20'	5'-0"	6'-8"	1'-5"	10"	10"	1'-0	1'-8"	6"	0'-11"
	20' - 30'	5'-0"	6'-8"	1'-10"	10"	10"	1'-0	1'-8"	6"	1'-4"
	30' - 40'	5'-0"	6'-8"	2'-2"	10"	10"	1'-0	1'-8"	8"	1'-6"
	40' - 50'	8'-0"	8'-8"	2'-6"	10"	10"	1'-0	1'-8"	8"	1'-9"
	50' - 60'	8'-0"	11'-8"	2'-8"	10"	10"	1'-0	1'-8"	9"	1'-10"
3	<20'	5'-0"	6'-8"	1'-8"	12"	12"	1'-0	1'-10"	7"	1'-1"
	20' - 30'	5'-0"	6'-8"	2'-0"	12"	12"	1'-0	1'-10"	7"	1'-4"
	30' - 40'	5'-0"	6'-8"	2'-4"	12"	12"	1'-0	1'-10"	9"	1'-7
	40' - 50'	8'-0"	8'-8"	2'-9"	12"	12"	1'-0	1'-10"	9"	2'-0"
	50' - 60'	8'-0"	11'-8"	3'-7"	12"	12"	1'-0	2'-6"	11"	2'-8"
5	<20'	5'-0"	6'-8"	2'-1"	16"	16"	1'-0	2'-6"	9"	1'-4"
	20' - 30'	5'-0"	6'-8"	2'-4"	16"	16"	1'-0	2'-6"	9"	1'-7"
	30' - 40'	5'-0"	6'-8"	2'-9"	16"	16"	1'-0	2'-6"	11"	1'-10"
	40' - 50'	8'-0"	8'-8"	3'-0"	16"	16"	1'-0	2'-6"	11"	2'-1"
	50' - 60'	8'-0"	11'-8"	3'-10"	16"	16"	1'-0	2'-6"	1'-2"	2'-8"

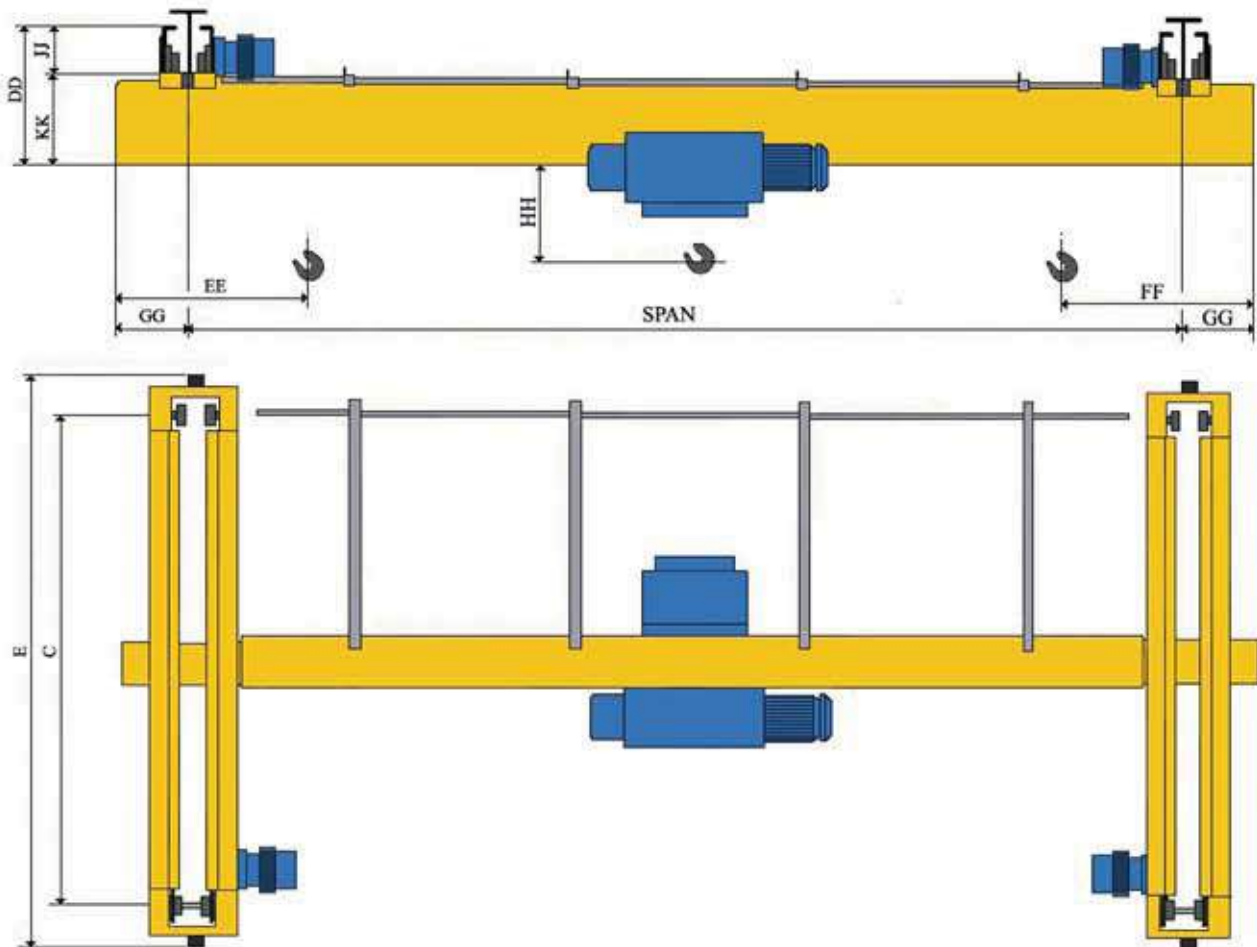

Motorized Single Girder Underslung Crane Bridge
TYPE UR-S

Capacity Tons	Span	C	E	DD	EE	FF	GG	Bridge H.P.	HH	JJ	KK
2	< 20'	5'-0"	6'-8"	1'-5"	1'-4"	1'-6"	1'-0"	1x .33	1'-11"	6"	0'-11"
	20' - 30'	5'-0"	6'-8"	1'-10"	1'-4"	1'-6"	1'-0"	1x .33	1'-11"	6"	1'-4"
	30' - 40'	5'-0"	6'-8"	2'-2"	1'-4"	1'-6"	1'-0"	1x .33	1'-11"	8"	1'-6"
	40' - 50'	7'-0"	8'-8"	2'-6"	1'-4"	1'-6"	1'-0"	1x .5	1'-11"	8"	1'-9"
	50' - 60'	10'-0"	11'-8"	2'-8"	1'-4"	1'-6"	1'-0"	1x .5	1'-11"	9"	1'-10"
3	<20'	5'-0"	6'-8"	1'-8"	1'-4"	1'-6"	1'-0"	1x .33	1'-11"	7"	1'-1"
	20' - 30'	5'-0"	6'-8"	2'-0"	1'-4"	1'-6"	1'-0"	1x .5	1'-11"	7"	1'-4"
	30' - 40'	5'-0"	6'-8"	2'-4"	1'-4"	1'-6"	1'-0"	1x .5	1'-11"	9"	1'-7"
	40' - 50'	7'-0"	8'-8"	2'-9"	1'-4"	1'-6"	1'-0"	1x .5	1'-11"	9"	2'-0"
	50' - 60'	10'-0"	11'-8"	3'-7"	1'-4"	1'-6"	1'-0"	1x .8	1'-11"	11"	2'-8"
5	<20'	5'-0"	6'-8"	2'-1"	1'-7"	1'-9"	1'-0"	2x .5	2'-4"	9"	1'-4"
	20' - 30'	5'-0"	6'-8"	2'-4"	1'-7"	1'-9"	1'-0"	2x .5	2'-4"	9"	1'-7"
	30' - 40'	5'-0"	6'-8"	2'-9"	1'-7"	1'-9"	1'-0"	2x .8	2'-4"	11"	1'-10"
	40' - 50'	7'-0"	8'-8"	3'-0"	1'-7"	1'-9"	1'-0"	2x 1.2	2'-4"	11"	2'-1"
	50' - 60'	10'-0"	11'-8"	3'-10"	1'-7"	1'-9"	1'-0"	2x 1.2	2'-4"	1'-2"	2'-8"

SINGLE
SOURCE

AND

SAVE

WITH OUR

CUSTOM CRANE KITS

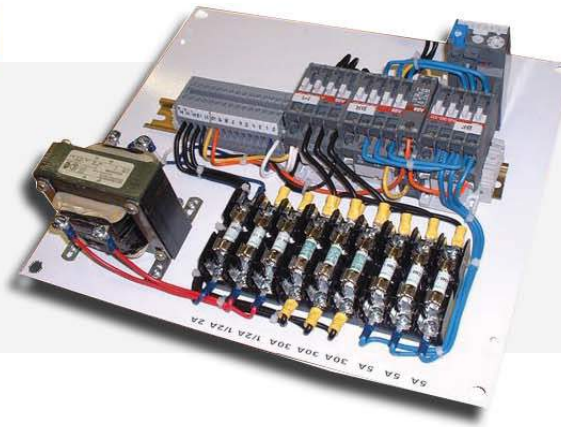

CRANE



WIRE ROPE HOIST



ELECTRICAL SYSTEM



END TRUCKS

= A CUSTOM CRANE PACKAGE THAT IS TAILOR-MADE TO YOUR SPECIFIC MATERIAL HANDLING NEEDS